

CUST. MODEL:	REF.
CUST. P/N:	DWG FILE:

DESCRIPTION CONTROL			
REV.	DESC.	DATE	APP.
1.0	RELEASE	03/09/11	Tony

RoHS Compliance

NOTE:INSULATOR ABS UL94V-0
METAL:STEEL/NICKEL PLATED

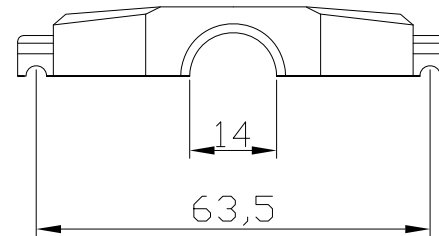
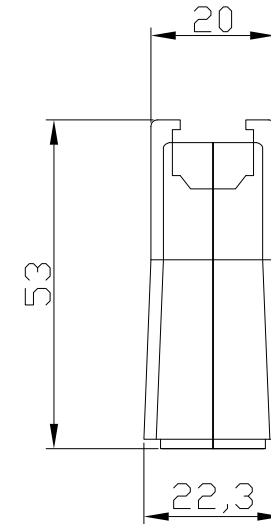
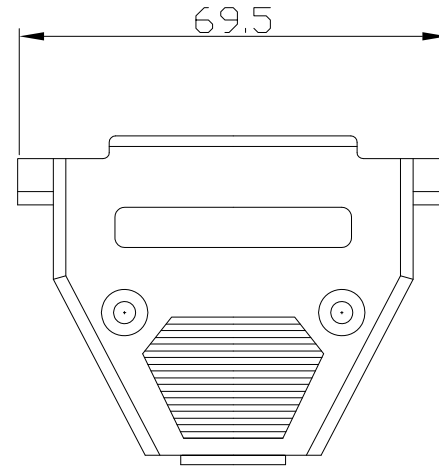
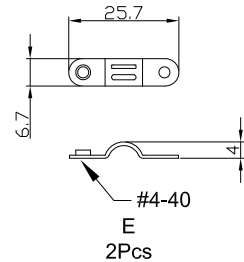
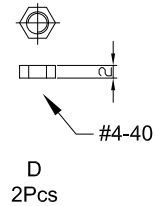
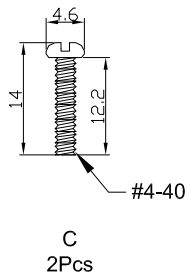
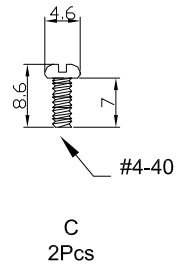
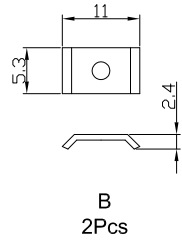
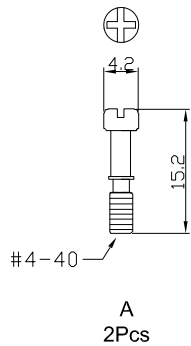

UNLESS OTHERWISE SPECIFIED SURFACE FINISH ALL OVER TOLERANCES mm METRIC X. = ±0.3 .X = ±0.2 .XX = ±0.1	DRAW: <i>CHUBBY</i>	DATE: 03/09/11	TITLE: D-SUB PLASTIC HOOD Lock Up Type Short Screw
	CHECK: KEVIN	APPROVE: <i>TONY</i>	MODEL CODE: PPH01-37-SSC

NO	DESCRIPTION	QTY
----	-------------	-----