

CUST. MODEL:	REF.
CUST. P/N:	DWG FILE:

RoHS Compliance

DESCRIPTION CONTROL			
REV.	DESC.	DATE	APP.
1.0	RELEASE	03/10/11	TONY

NOTE:INSULATOR ABS UL94V-0 PLATED
WITH NICKEL/CHORME
METAL:STEEL/NICKEL PLATED

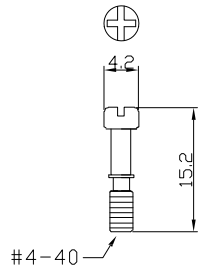

A
2Pcs

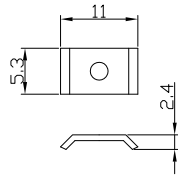

B
2Pcs

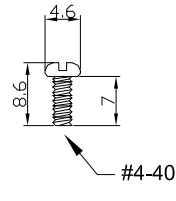

C
2Pcs

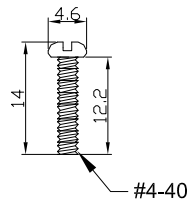

D
2Pcs

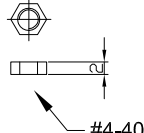

E
2Pcs

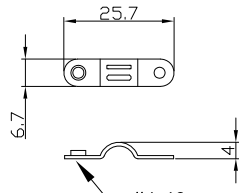

F
2Pcs

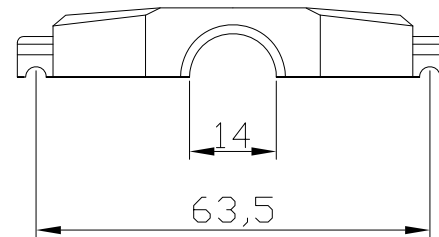
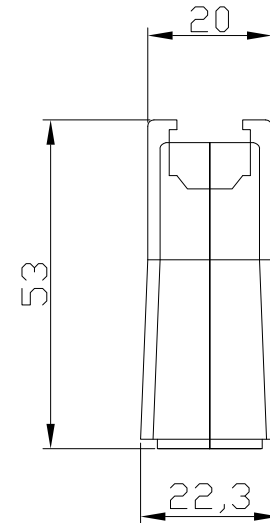
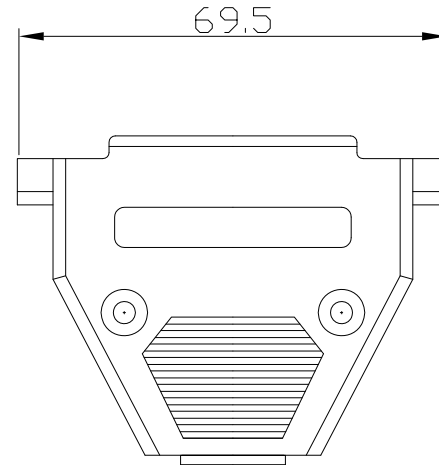

UNLESS OTHERWISE
SPECIFIED SURFACE
FINISH ALL OVER
TOLERANCES mm

METRIC

X. = ±0.3
.X = ±0.2
.XX = ±0.1

DRAW:

CHUBBY

DATE:

03/10/11

TITLE:

D-SUB EMI HOOD Short Screw

MODEL CODE:

SPH01-37-SSC

CHECK:

KEVIN

APPROVE:

TONY

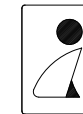

誠州電子有限公司

Sincere State Electronics Co.,Ltd.

NO	DESCRIPTION	QTY
----	-------------	-----